

# GEMINO<sup>+</sup>

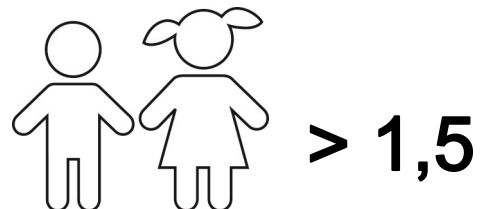

## Auf-und-Ab-Doppelwelle 259019



**HABA Sales GmbH & Co. KG**  
August-Grosch-Straße 28-38  
96476 Bad Rodach  
Germany

---

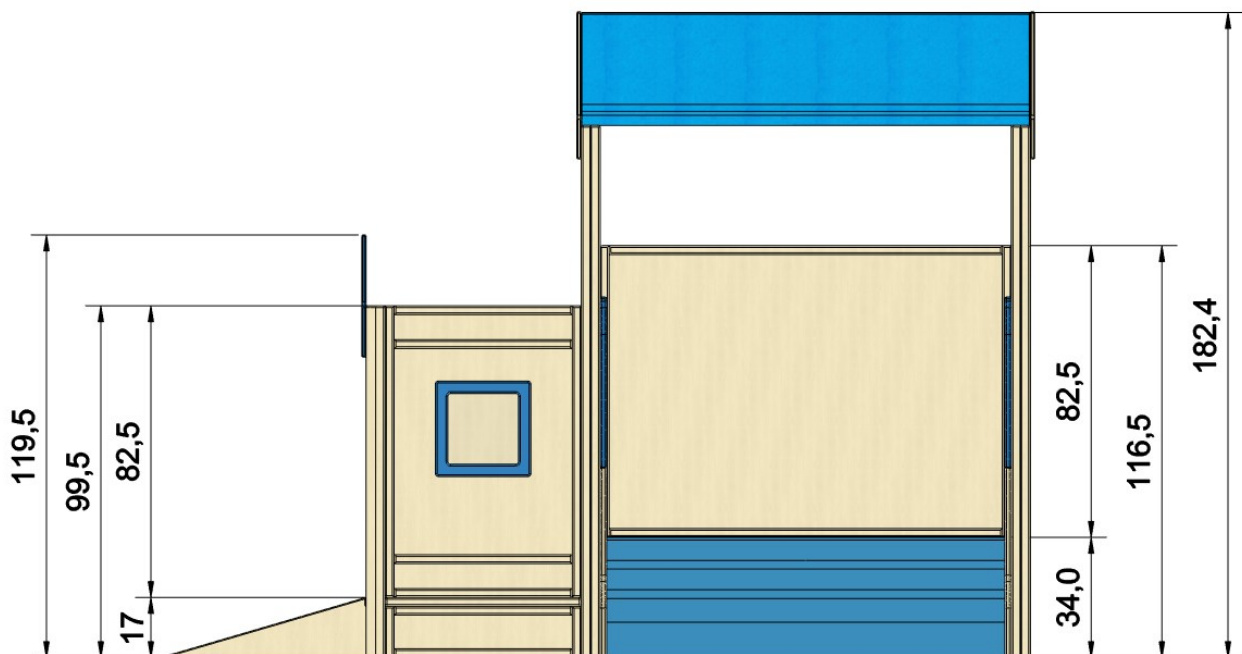
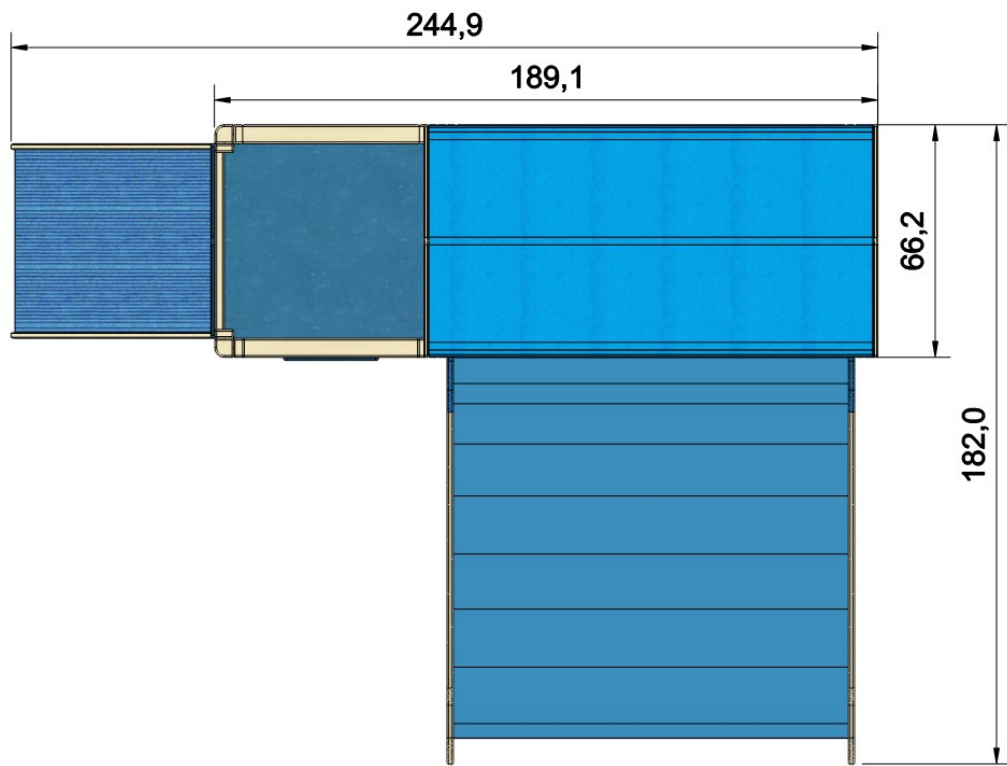

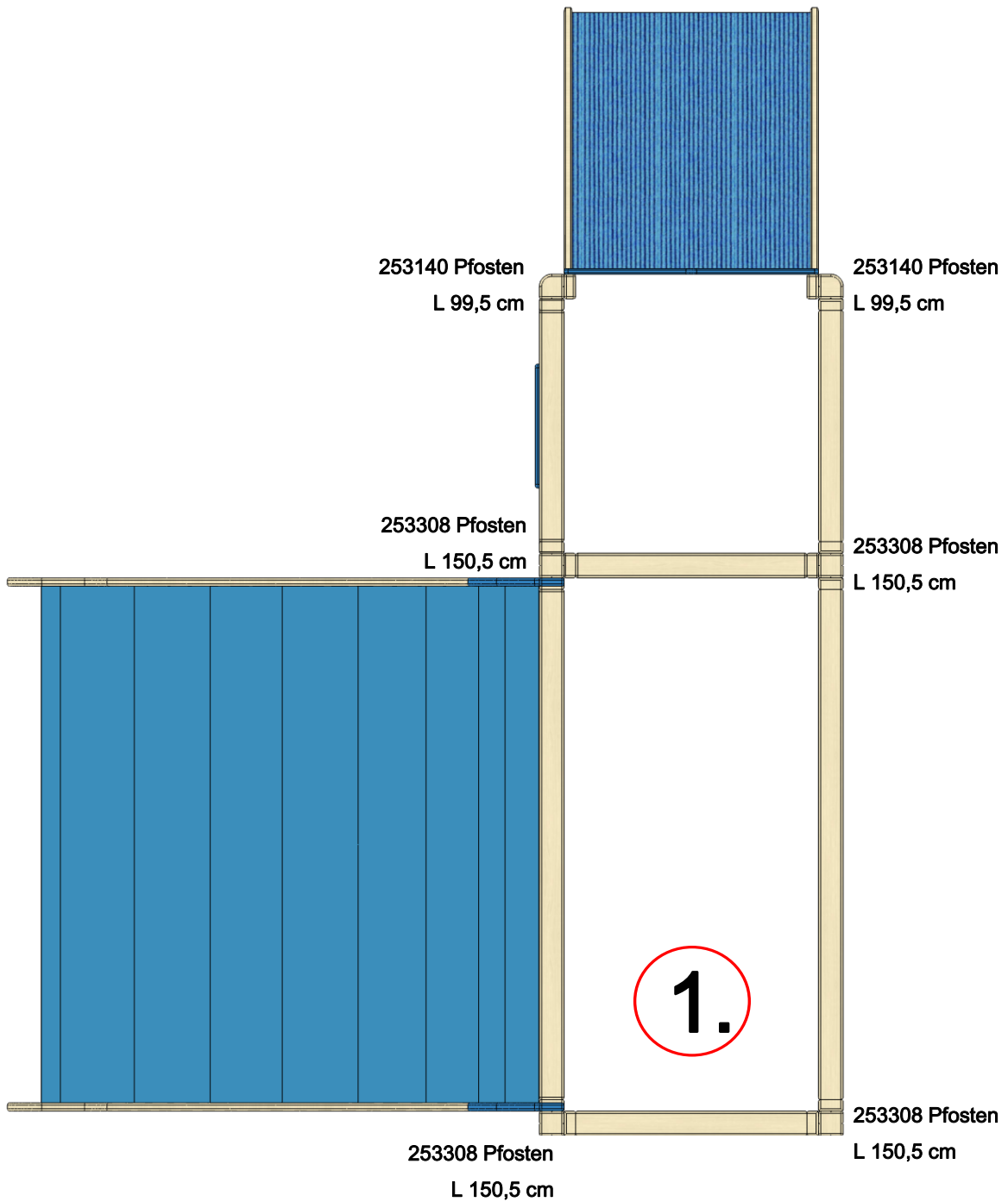

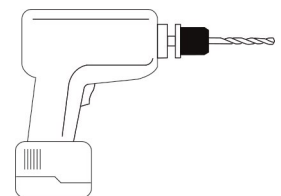
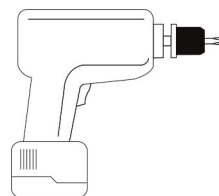
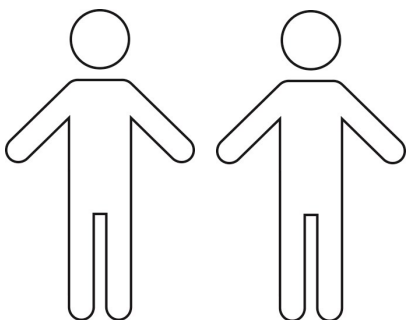
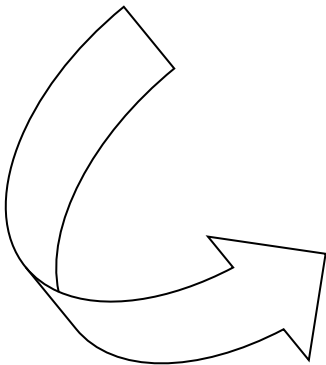

1.

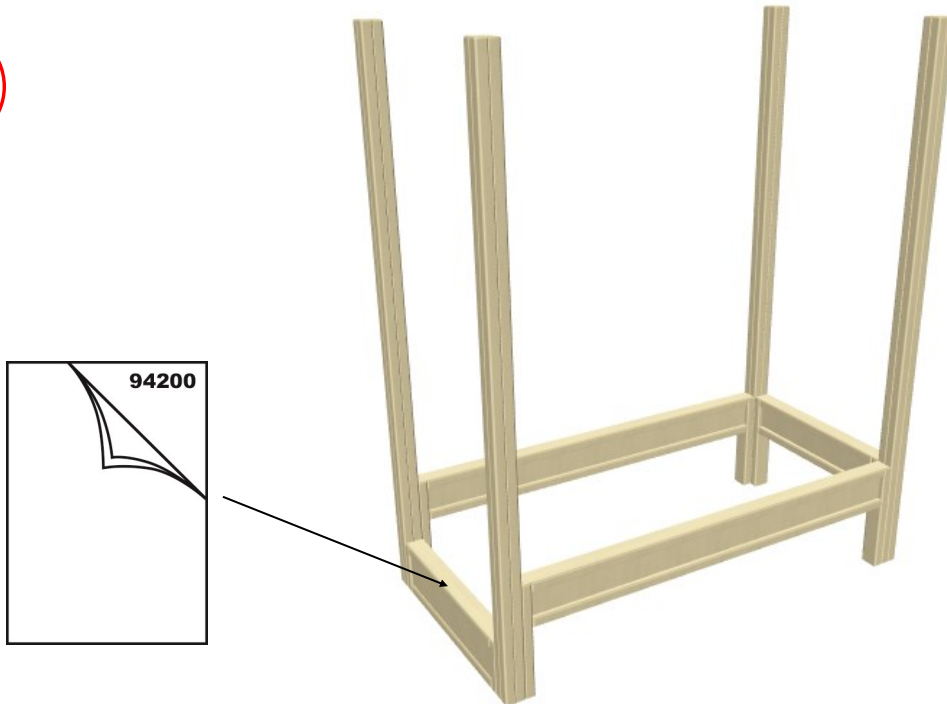

2.

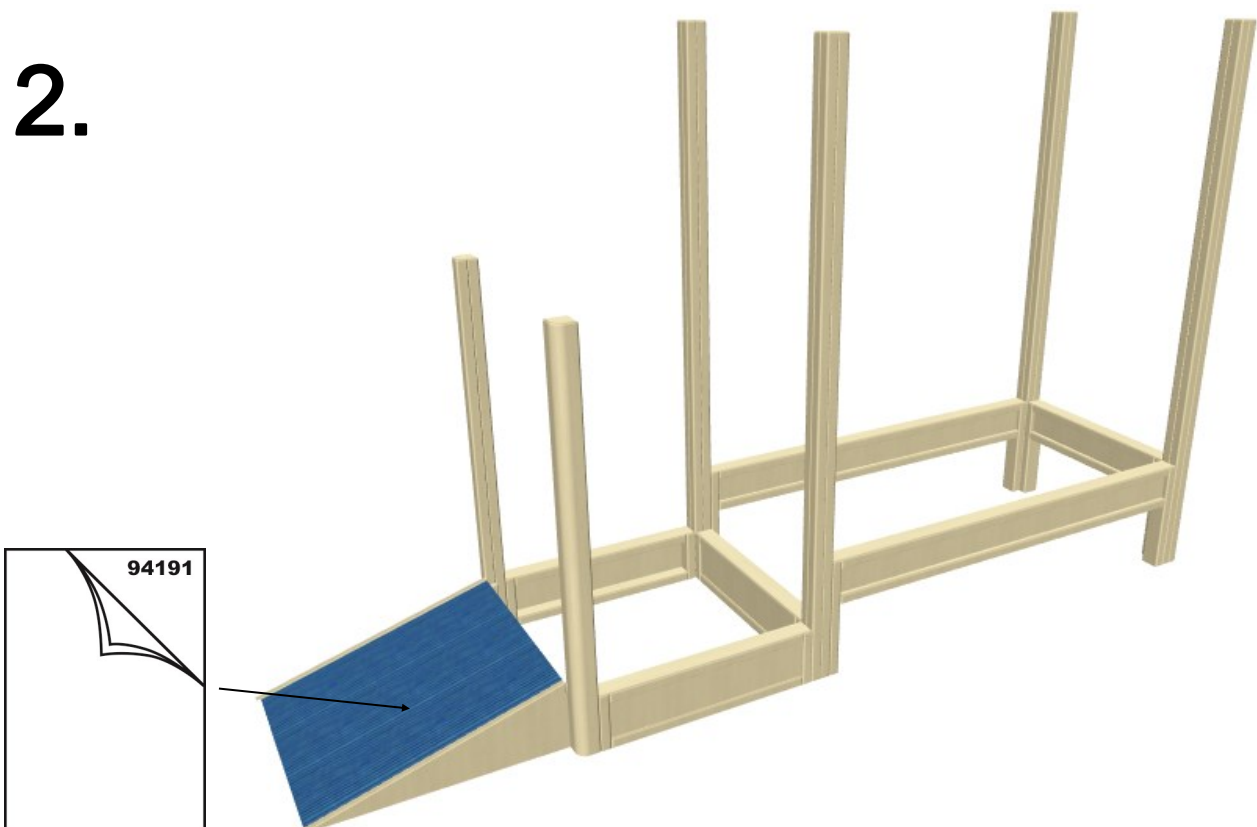

3.

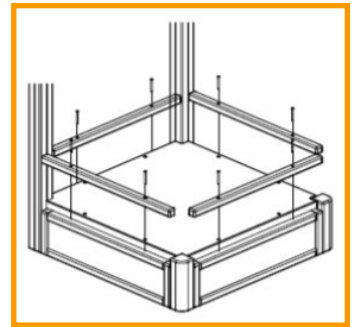
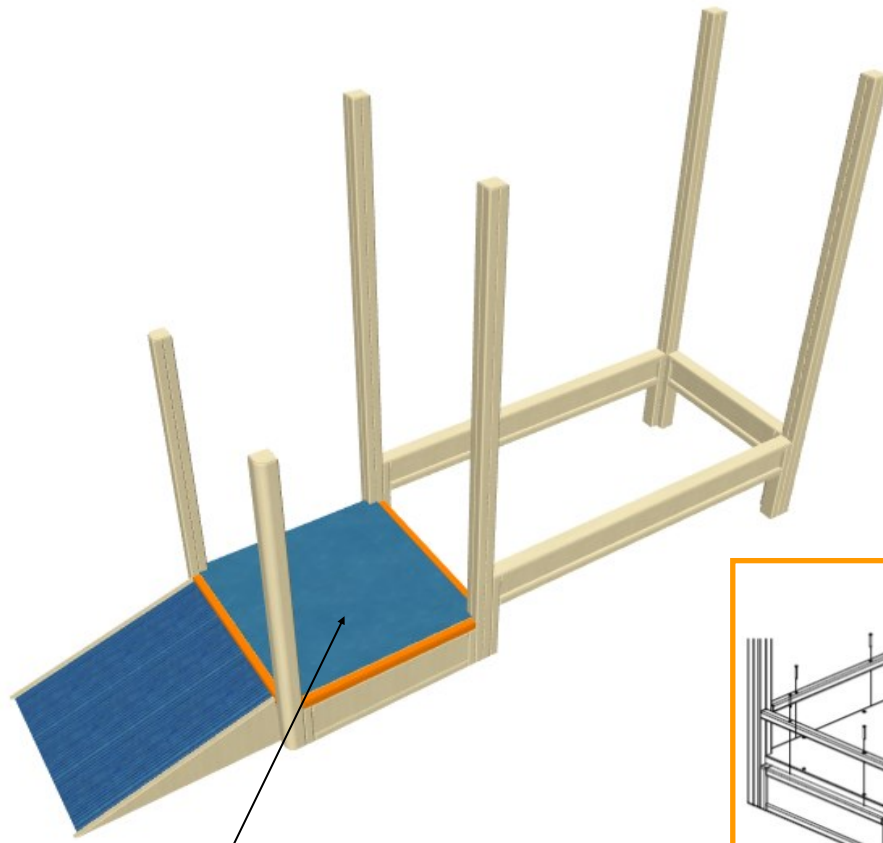

4.

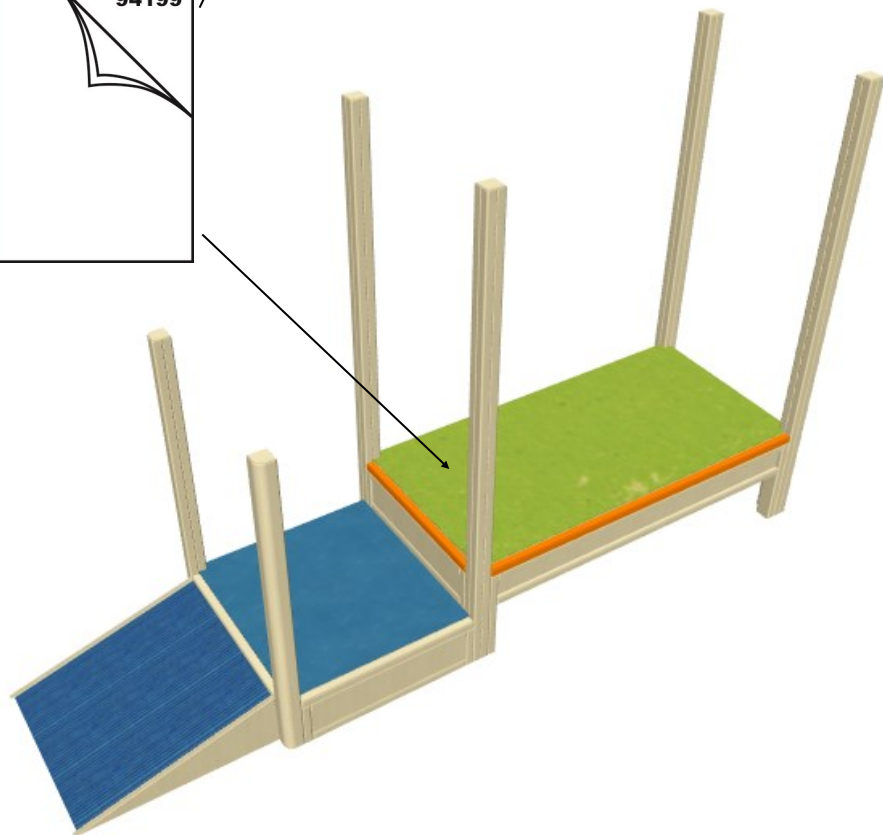
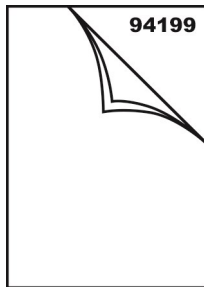



5.

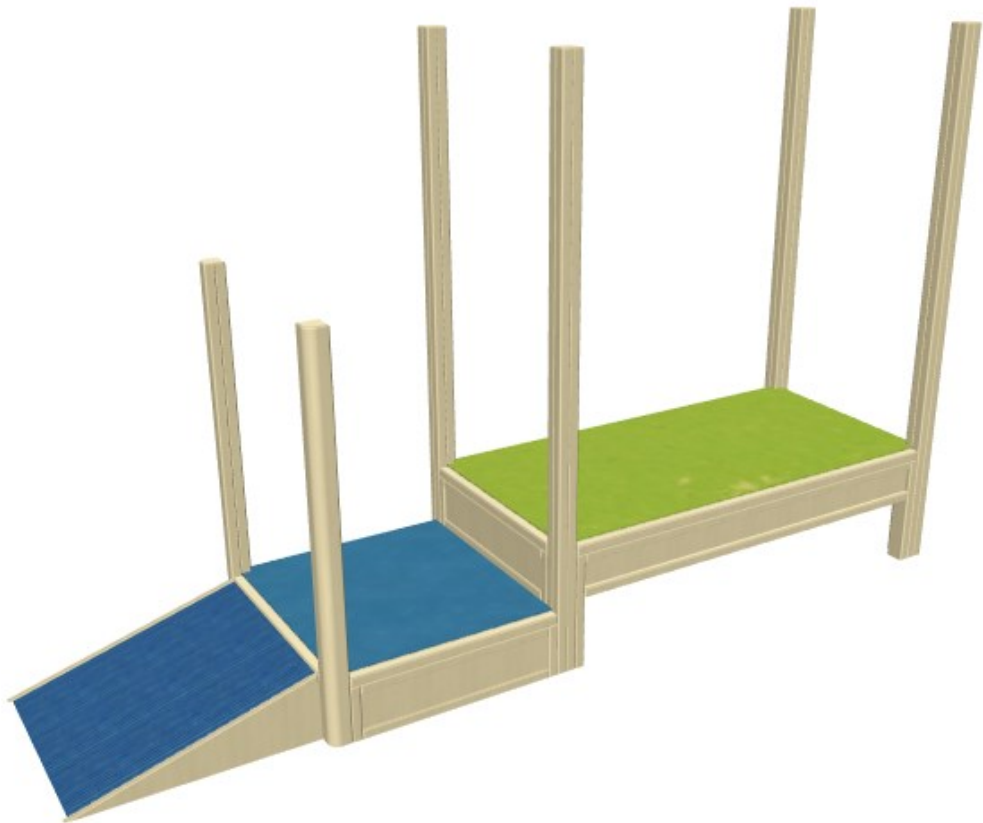

6.

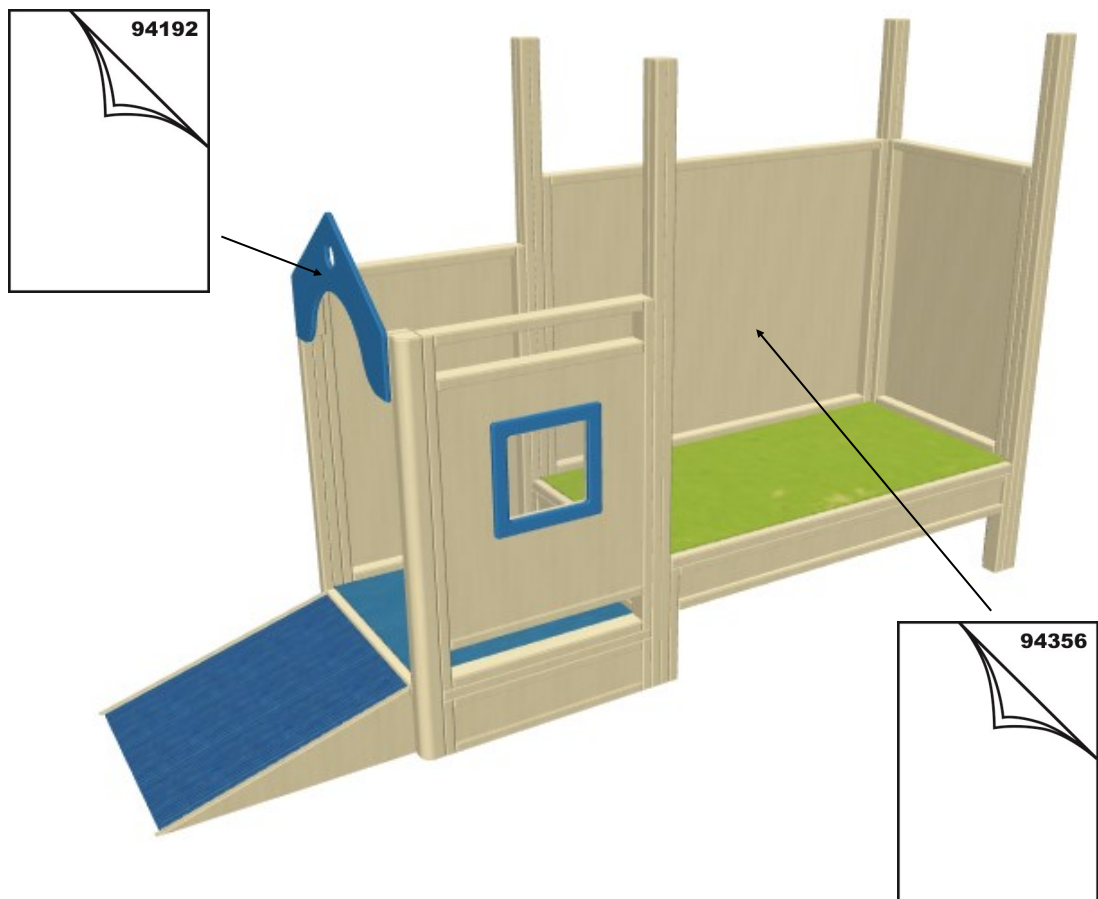

7.

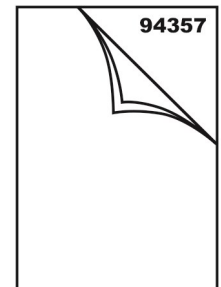
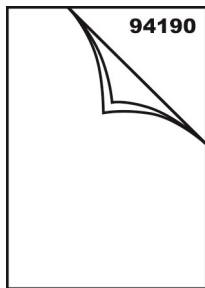

8.

